



TECHNICAL DATASHEET

TOPLA TOP JIS TT75J

ORDER INFORMATION

TAB ID
118875

Short Code
TT75J

DIN Marking
57529 SMF

EAN Code
3838807030671

Quantity per EU/CNT pallet
48/80 pcs

TECHNOLOGY

Primary Function
Engine Start

Battery Technology
Flooded

Grid Type (pos/neg)
Expanded/Concasted

Grid Alloy (pos/neg)
Ca/Ca

Separator
PE

Electrolyte (g/cm³)
1,28

TECHNICAL INFORMATION

Voltage (V)
12

Capacity C20 (Ah)
75

CCA -18°C EN (A)
740

RC (min)
130

LxWxH (mm)
259x175x200/221

Total Weight (kg)
17.8

BOX DESIGN

Box Type
D26

Cover Type
SMF

Colour
Black

Layout
0

BHD
B1

Terminal
1

DRAWING

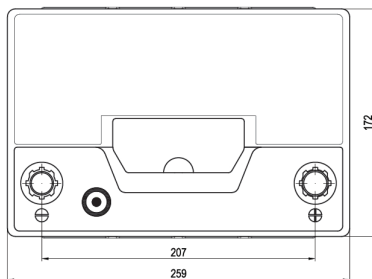
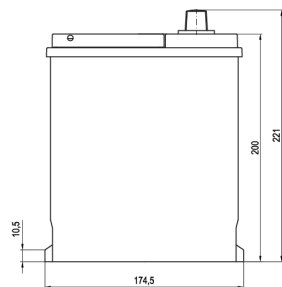
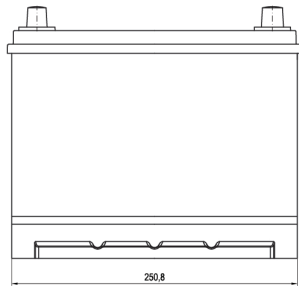

BHD

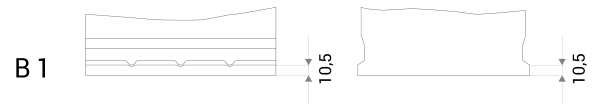

LAYOUT

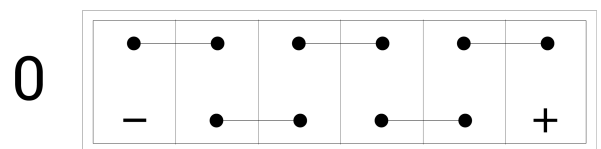

TERMINAL

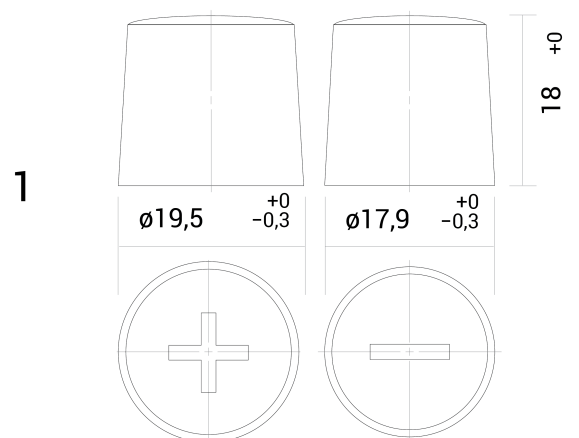

TECHNICAL DATASHEET

TOPLA TOP JIS TT75J