



TECHNICAL DATASHEET

TOPLA ENERGY E100H

ORDER INFORMATION

TAB ID
108400

Short Code
E100H

DIN Marking
60044

EAN Code
3838807027527

Quantity per EU/CNT pallet
36/60 pcs

TECHNOLOGY

Primary Function
Engine Start

Battery Technology
Flooded

Grid Type (pos/neg)
Expanded/Concasted

Grid Alloy (pos/neg)
Ca/Ca

Separator
PE

Electrolyte (g/cm³)
1,28

TECHNICAL INFORMATION

Voltage (V)
12

Capacity C20 (Ah)
100

CCA -18°C EN (A)
900

RC (min)
182

LxWxH (mm)
353x175x190

Total Weight (kg)
22.5

BOX DESIGN

Box Type
L5

Cover Type
Kamina

Colour
Red

Layout
0

BHD
B13

Terminal
1

DRAWING

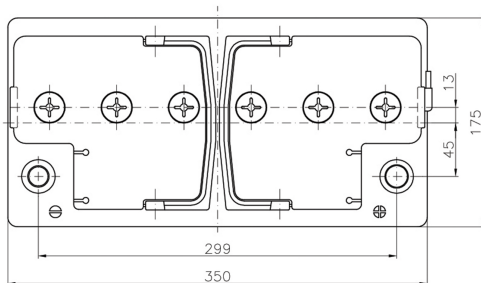
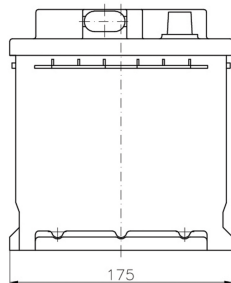
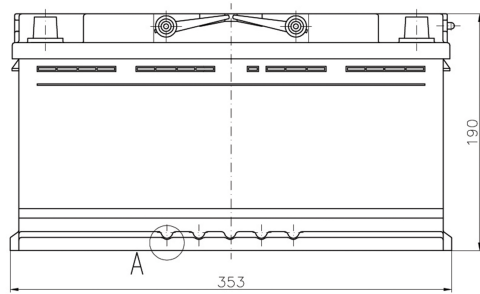

BHD

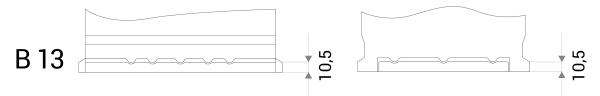

LAYOUT

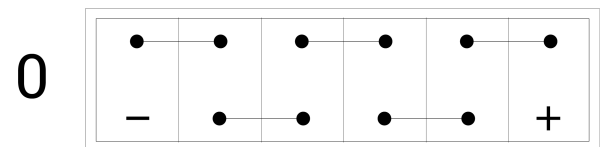

TERMINAL

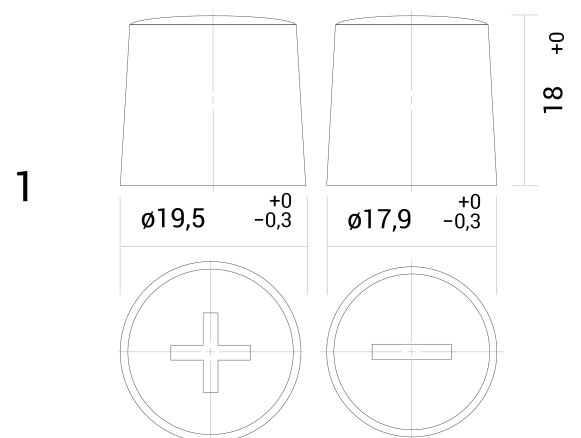

TECHNICAL DATASHEET

TOPLA ENERGY E100H